

Installation Instructions

Kawasaki



Clutch Slave Cylinder CLU-2775

Enclosed:

- 1 off fully assembled clutch slave unit
- 2 off sealing washers
- 3 off M6 x 20mm bolts
- 1 off M6 x 110mm bolt

Use only Kawasaki recommended fluid.

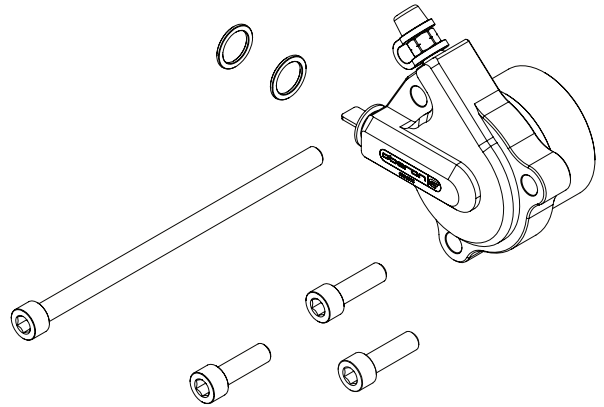

Preparation:

Before installing your new purchase please read and understand these instructions fully and make sure you have the following items to hand, 5mm Allen Key, 12mm socket wrench, 10mm ring spanner, 8mm ring spanner, flat screwdriver, a suitable catch vessel and 500ml+ of manufacturer's approved clutch fluid (Ensure you are 100% familiar with their instructions on use before commencing Installation).

THESE INSTRUCTIONS ONLY APPLY WHEN THE MOTORCYCLE HAS THE ORIGINAL STOCK CLUTCH FITTED.

Installing the slave cylinder:

1. Remove any fairing (where necessary) to ensure entire area is easily accessible. The bike will need to be held upright or slightly away from the side stand to assist the escape of air bubbles.
2. Have a cloth wrapped around the existing clutch body when loosening (but not removing) the banjo bolt to minimise the spread of fluid. When loosening the bolt ensure your catch vessel is in place for any escaping fluid. Remove the existing cylinder from the engine keeping the clutch line and original cylinder together while completely wrapped in cloth.
3. *IMPORTANT* The OEM black plastic 3mm spacer is built into the Oberon slave cylinder so this part is no longer required. Meticulously clean the mating surface and remove all traces of rust and corrosion. The clutch slave cylinder is pre-assembled and is ready to go straight on. Attach the new slave to the bike using the new fasteners provided.
4. Once the new slave cylinder is attached to the bike (ensuring great care is taken when attaching) it can be completely filled with clutch fluid. The pipe and banjo bolt can be removed from the original cylinder and attached to the new one. Do this as quickly and safely as possible to curb later bleeding times. When attaching the banjo bolt to the new slave cylinder be also sure to use the sealing washers provided to reseal the connection.
5. Bleed the system through the original bleed valve at the top of the slave cylinder ensuring a pipe is attached and leading to the catch vessel. Apply approximately six pulls on the clutch lever (holding the lever in on the last stroke). Loosen the valve to release the fluid's pressure and tighten before releasing the lever. Repeat this until the clutch no longer feels 'spongy'. Also ensure the clutch reservoir levels do not drop low and draw in air.

Installation is complete and you may now enjoy the benefits of your new Oberon clutch slave cylinder. The clutch at first will feel light due to the increased efficiency but it won't take long to adjust to the effortless and smoothness of the new clutch system.

WARNINGS

DO NOT push against the piston once the cylinder is filled as fluid could be ejected and may cause injury.
DO NOT operate the slave cylinder off of the engine, the piston may be ejected - or cause damage to the seals and piston.

Product diagnosis in the event of a suspected leak or failure.

1. How often are you refilling the clutch master cylinder?
2. Oil leaks? Check whether it is gearbox, chain or hydraulic oil.
3. Ensure the pressure plate bearing is running freely – taking care to ensure the pushrod is NOT being 'driven'.
4. The seals are manufactured from special materials and purposely machined as a hydraulic seal. Therefore they have an extremely long life and very rarely need replacement (unlike common 'O' rings or inferior seals).
5. Please contact admin@oberon-performance.co.uk for further guidance where needed.