

ITEM NO.	DESCRIPTION	QTY
1	Preload adjuster	2
2	M4 x 6mm Grub Screw	6

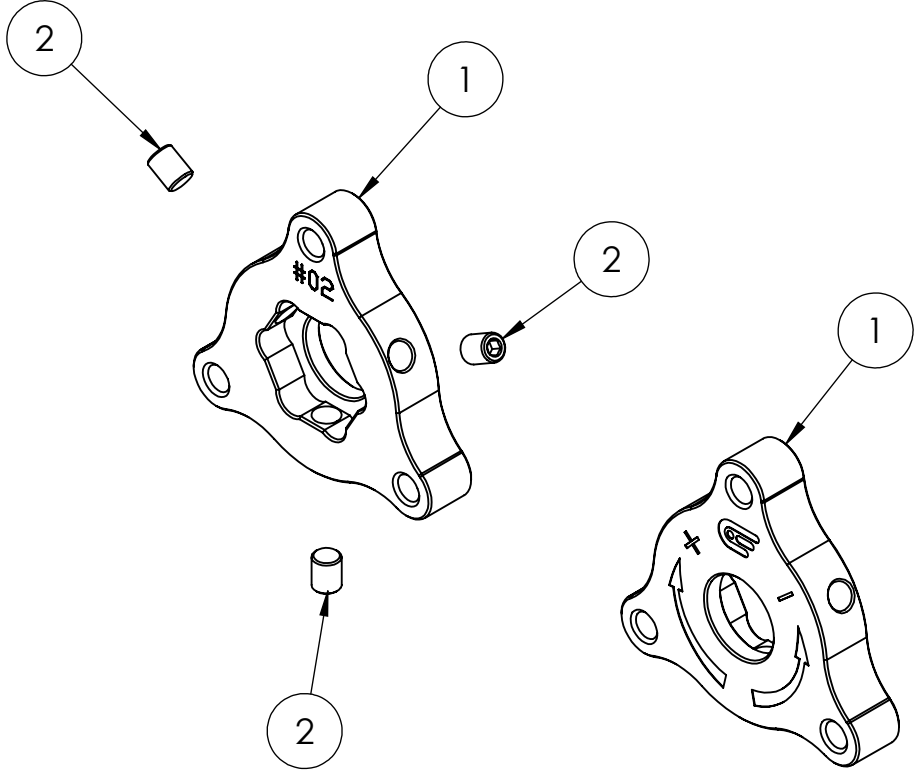

DO NOT SCALE DRAWING REVISION:



TITLE:
Whats in the box.

PROPRIETARY AND CONFIDENTIAL
 THE INFORMATION CONTAINED IN THIS DRAWING IS THE SOLE PROPERTY OF OBERON PERFORMANCE LTD. ANY REPRODUCTION IN PART OR AS A WHOLE WITHOUT THE WRITTEN PERMISSION OF OBERON PERFORMANCE LTD IS PROHIBITED.

DWG NO: PRE-0002 A4

SCALE: