

8 7 6 5 4 3 2 1

ITEM NO.	DESCRIPTION	QTY
1	Racing Footpeg	2
2	Studded Footpeg with studs	2
3	Touring Footpeg	2
4	M6 x 16mm	2

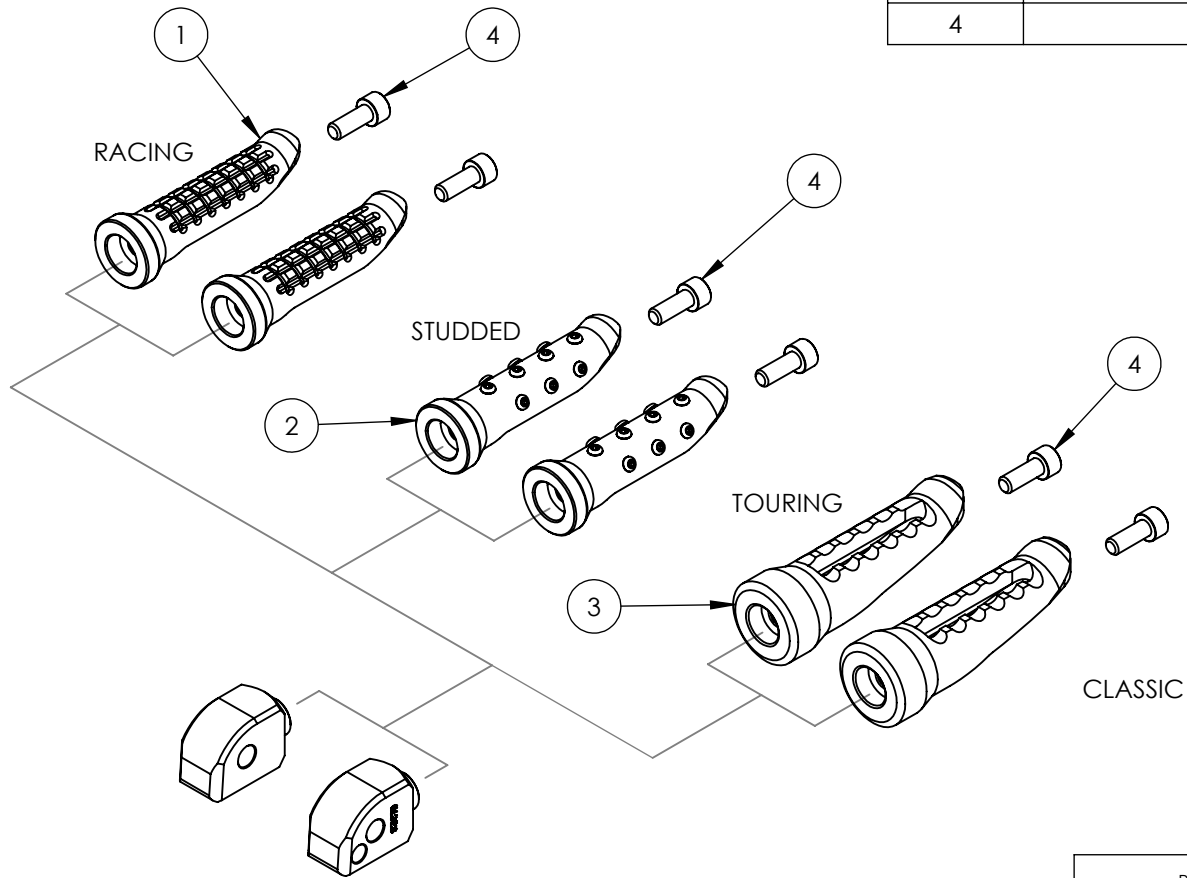

ITEM NO.	DESCRIPTION	QTY
1	Bike Specific Adaptor	2

DO NOT SCALE DRAWING	REVISION:
----------------------	-----------



TITLE:
Whats in the box.

PROPRIETARY AND CONFIDENTIAL
THE INFORMATION CONTAINED IN THIS DRAWING IS THE SOLE PROPERTY OF OBERON PERFORMANCE LTD. ANY REPRODUCTION IN PART OR AS A WHOLE WITHOUT THE WRITTEN PERMISSION OF OBERON PERFORMANCE LTD IS PROHIBITED.

DWG NO:	FP-0132	A4
---------	---------	----

SCALE:

8 7 6 5 4 3 2 1

F
E
D
C
B
A

F
E
D
C
B
A