

8 7 6 5 4 3 2 1

ITEM NO.	DESCRIPTION	QTY
1	Racing Footpeg	2
2	Studded Footpeg with studs	2
3	Touring Footpeg	2
4	M6 x 16mm	2

F

E

D

C

B

A

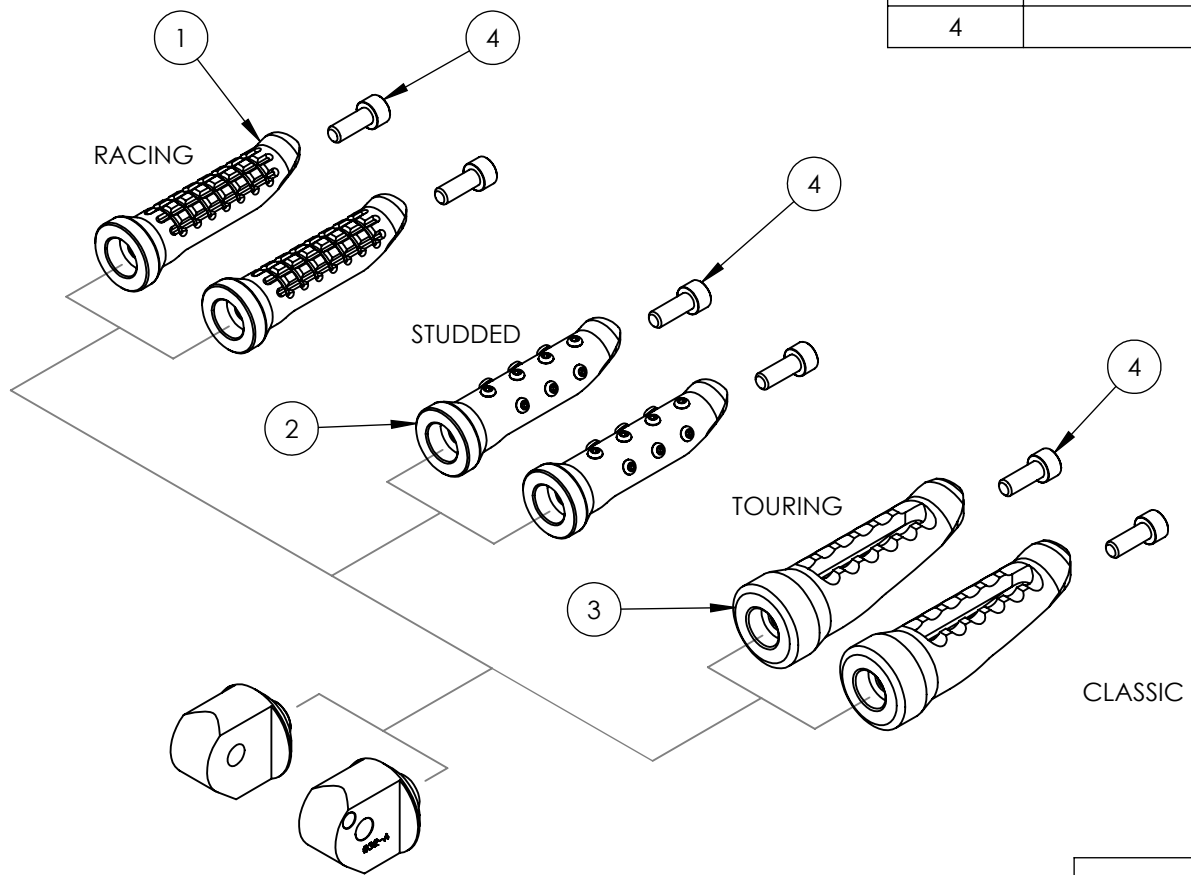

ITEM NO.	DESCRIPTION	QTY
1	Bike Specific Adaptor	2

PROPRIETARY AND CONFIDENTIAL

THE INFORMATION CONTAINED IN THIS DRAWING IS THE SOLE PROPERTY OF OBERON PERFORMANCE LTD. ANY REPRODUCTION IN PART OR AS A WHOLE WITHOUT THE WRITTEN PERMISSION OF OBERON PERFORMANCE LTD IS PROHIBITED.

DO NOT SCALE DRAWING		REVISION:
		
TITLE:		
Whats in the box.		
DWG NO:		A4
FP-0032		
SCALE:		

8 7 6 5 4 3 2 1